

KMW[®]

KÜHLMÖBELWERK

Qualität aus Deutschland

Operating Manual

Refrigerated display cabinet

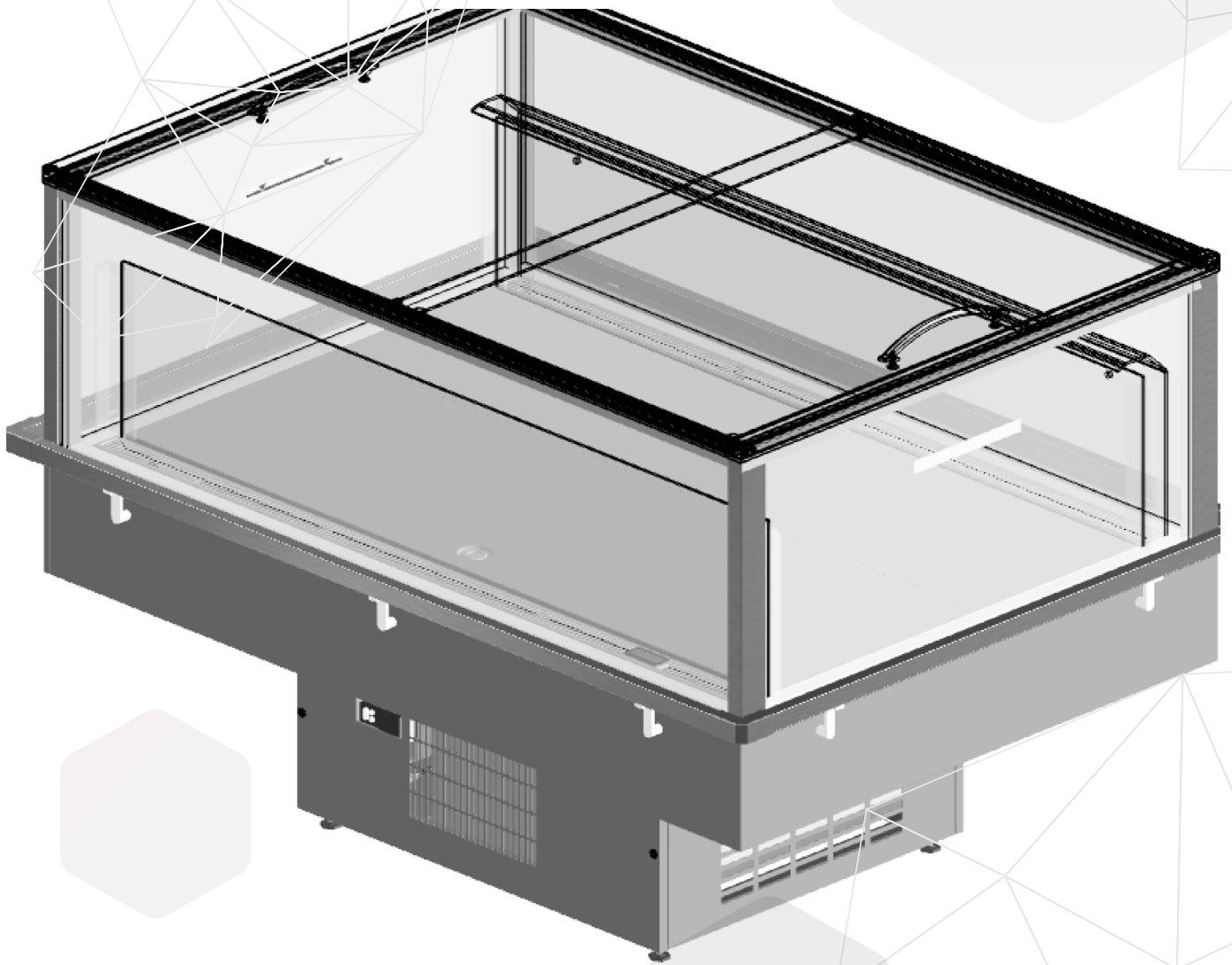

Borkum

Commercial refrigerated cabinet

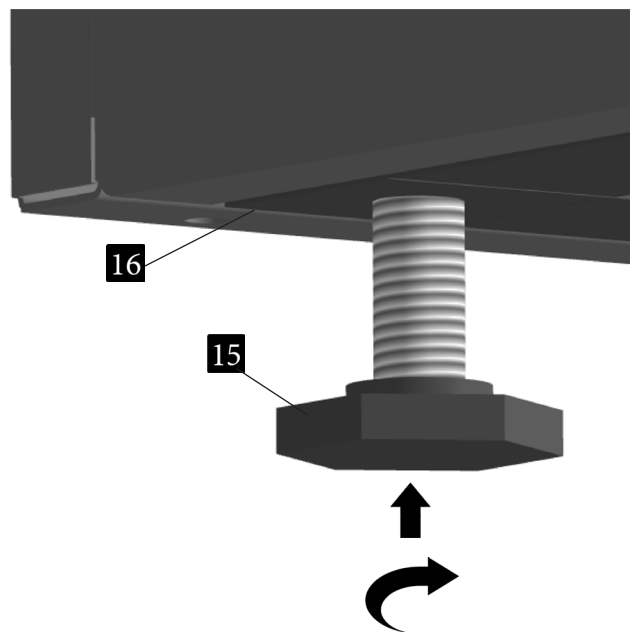
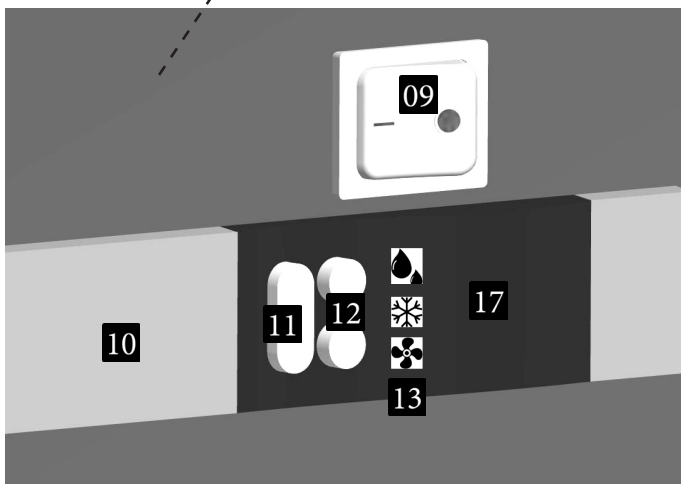
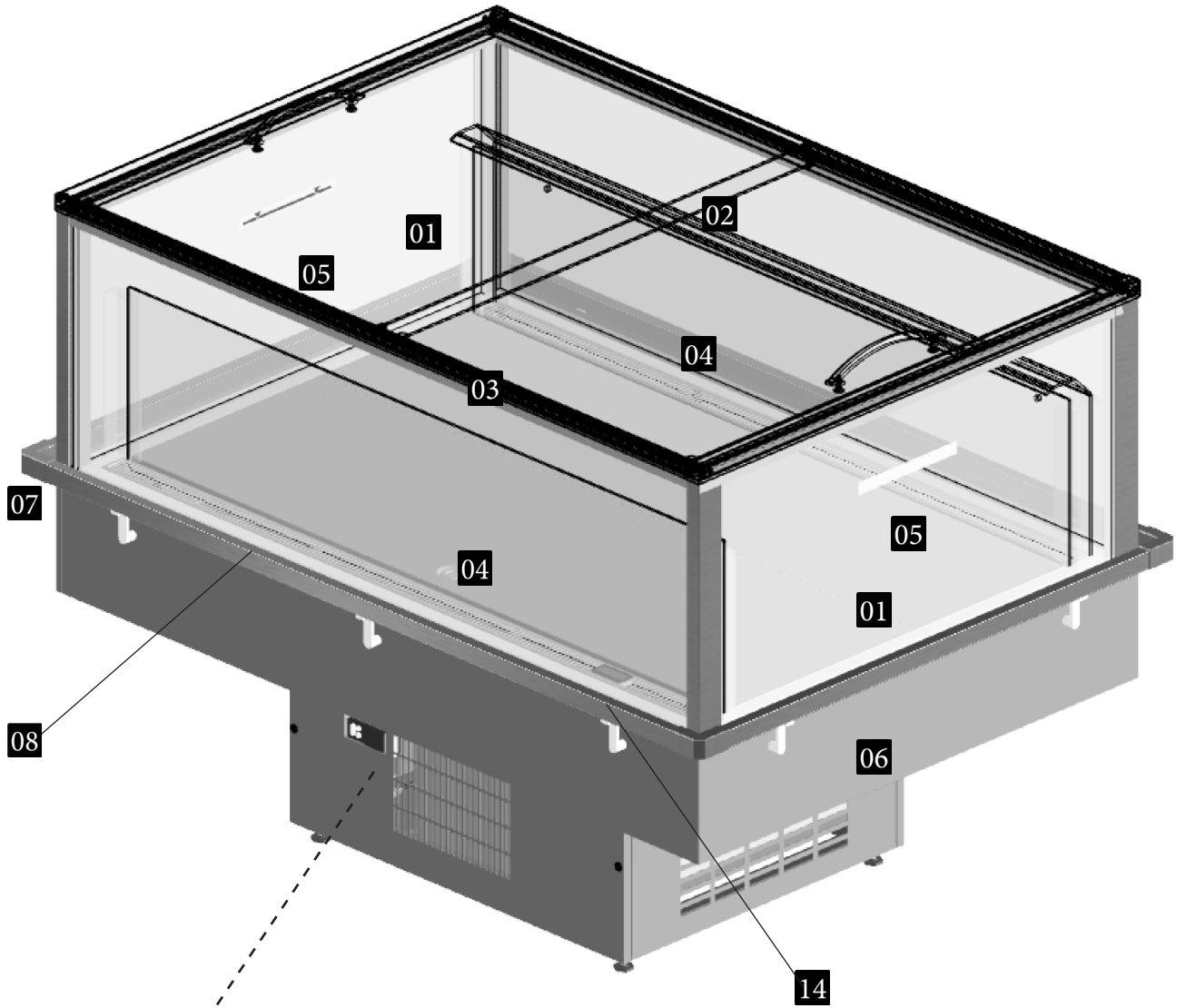

 defrost running
  cooling is running
  fans are running

- 01 glass panes outside
- 02 sliding glass lid
- 03 floor display
- 04 baffle plate inside
- 05 load limit line
- 06 decorative panel
- 07 impact protection
- 08 air intake grille
- 09 light switch LED (optional)
- 10 thermostat controller
- 11 program keys
- 12 button forward back
- 13 display icons 
- 14 temperature display
- 15 adjustable feet with thread M10
- 16 substructure
- 17 temperature display, weighted air inlet and air outlet temperature

Contents

General	5
Read and keep the operating instructions	5
Explanation of symbols	5
Intended Use	6
Safety	7
Danger of explosion	8
Risk of ignition and explosion	8
Electric shock hazard	8
Safety instruction for the authorized specialist	9
Risk of health consequences	10
Risk of injury	10
Malfunctions caused by electromagnetic interference	10
Lineup	11
Installation	12
Electric shock warning	12
Electric circuit protection	12
Electric circuit breaker	12
Connect and disconnect the refrigerated island from the power supply	12
Cleaning	13
Do not clean with:	13
Defrosting	13
Defrosting of devices without bus connection	13
Defrosting of devices with bus connection	13
Maintenance	14
Risk of injury	14
Risk of short circuit	14
Decommissioning, transport and storage	15
Product details and functionality	15
Climate class	15
Cooling unit	15
Housing and cooling storage	15
Temperature controller / Refrigeration controller	16
Troubleshooting and service	17
Contact address	17
Technical specifications	17
Disposal	18
Dispose of packaging	18
Dispose of the cooling island	18
Energy label Climate Class III (25°C;60%r.F.)	18
Declaration of Conformity	19
Imprint	20

General

Read and keep the operating instructions



This operating instructions belong to the Borkum model series (hereinafter referred to as "refrigerated island"). It contains important information on commissioning and handling.

Read the operating instructions carefully, especially the safety instructions, before using the refrigerated island. Failure to follow these operating instructions can result in serious injury or damage to the refrigerated island.

The operating instructions are based on the standards and regulations valid in the European Union. Also observe country-specific guidelines and laws abroad.

Keep these operating instructions for further use. If you pass the refrigerated island on to third parties, be sure to include these operating instructions.

Explanation of symbols

The following symbols and signal words are used in this manual, on the refrigerated island or on the packaging:



Danger!

This signal symbol/word indicates a hazard with a high level of risk which, if not avoided, will result in death or serious injury.



Warning!

This signal symbol/word indicates a hazard with a medium level of risk which, if not avoided, will result in death or serious injury.



Caution!

This signal symbol/word indicates a hazard with a low level of risk which, if not avoided, will result in minor or moderate injury.

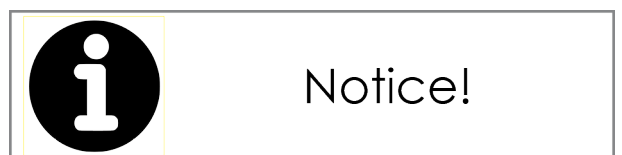

Notice!

This signal word warns of possible damage of property.



This symbol gives you useful additional information on installation or operation.



Products marked with this symbol comply with all applicable Community regulations of the European economic area (see chapter „Declaration of Conformity“).



Warning of flammable substances



Warning of electrical voltage



Warning of hot surfaces



Warning of explosive substances



Entering the area prohibited



Read the manual

Intended use



Notice!

The refrigerated island is a commercial refrigeration furniture. It is designed as sales furniture for packaged food in the temperature class M1 and M5 in the self-service area. This refrigerated island is not suitable for use on board ships or aircraft.

It must be ensured at all times that the set and reached temperature within the refrigerated island corresponds to the respective storage temperature for the food in question.

Safety

The refrigerated island is glazed all around and is delivered fully assembled (ready to plug in). Apart from the correct alignment at the installation site, no final assembly by the user is required.



The person responsible on site (e.g. the store manager in the case of installation in a supermarket) must ensure that the operators of the refrigerated island at the installation site are instructed in the correct use of the operating instructions and are familiar with it.

The refrigerated island meets all the requirements of EU Directive 2011/65EU (RoHS2) on the avoidance of hazardous substances in electrical and electronic equipment and EU Directive 1907/2006 (REACH) on the registration, evaluation and approval of chemicals. The cooling system installed in the refrigerated island works with the refrigerant R290 (propane) and the insulating foam polystyrene.

- The global warming potential (GWP) corresponds to the value 3 and the ozone depletion potential (ODP) to the value 0.



Technical data and filling quantities can be found on the type plate of the refrigerated island, as well as on the product data sheet, which you can obtain from KMW customer service.

Only use the cooling island as described in this user manual. Any other use is considered improper and can lead to property damage or even personal injury. The refrigerated island is not a child's toy. The manufacturer assumes no liability for any injury, loss or damage resulting from improper or incorrect use. Possible examples of improper or incorrect use are:

- Use of the refrigerated island for purposes other than those for which it is intended
- Non-observance of the safety instructions and warnings, as well as the assembly, operation, maintenance and cleaning instructions contained in this operating manual
- Non-observance of any accident prevention regulations specific to the use of the refrigerated island and/or generally applicable
- Use of accessories and spare parts that are not intended for the cooling island
- Changes to the cooling island
- Repair of the refrigerated island by someone other than the manufacturer or a specialist
- Operation or maintenance of the refrigerated island by persons who are unfamiliar with the handling of the refrigerated island and/or do not understand the hazards involved.

Danger of explosion



There is a risk of explosion if the refrigerated island is used or handled improperly.

Do not store any explosive substances such as aerosol containers with flammable propellants in the refrigerated island.

Risk of ignition and explosion



The refrigerated island is operating with the refrigerant R290 (propane). According to the DIN EN 378-1 standard, this is assigned to the refrigerant group A3 (flammable and explosive). If the refrigeration island is handled improperly, there is a risk that an inflammable gas-air mixture will form and be unintentionally ignited.



Warning!

Never close the ventilation openings.



Warning!

To speed up the defrosting process do not use any mechanical devices or other utilities than those recommended by the manufacturer.



Warning!

Never damage the refrigerant circuit.



Warning!

Do not operate with any electrical equipment inside the refrigerator that is not of the type recommended by the manufacturer.

Electrical shock hazard



Faulty electrical installation or excessive mains voltage can lead to electric shock

Safety instructions for the user

- Only connect the refrigerated island if the main voltage and main frequency of the socket correspond to the information on the type plate
- Only connect the refrigerated island to an easily accessible socket so that you can quickly disconnect the refrigerated island from the mains in the event of a fault
- Do not operate the cooling island if it is visibly damaged or if the mains connection cable or mains plug is defect.
- If the mains connection cable of the refrigerated island is damaged, it must be replaced by the manufacturer or its customer service or a similarly qualified person in order to avoid hazards.
- Do not open the housing, leave repairs to authorized specialists. To do this, contact KMW customer service. Liability and guarantee claims are excluded in case of repairs carried out independently, improper connection or incorrect operation.
- Do not touch the power plug of the refrigerated island with wet hands.
- Never pull the mains plug of the refrigerated island out of the socket by the mains connection cable, always hold the mains plug.
- Keep the refrigerated island, the mains plug and the mains connection cable away from open flames and hot surfaces.
- Lay the mains connection cable in such a way that it does not become a tripping hazard.
- Do not kink the power cord and do not lay it over sharp edges.
- Only use the refrigerated island in dry indoor areas.
- Disconnect the refrigerated island

from the power supply by unplugging the power cord from the outlet when cleaning the refrigerated island or when servicing the refrigerated island. During the entire cleaning and maintenance process, it must be ensured that the refrigerated island is disconnected from the power supply. The operator must be able to check whether the mains plug is outside the socket during the entire cleaning or maintenance process.

- If you discover or suspect malfunctions or damage to the temperature controller that endanger safe operation, take the refrigerated island out of operation immediately.
- Only allow repair and maintenance work or adjustments at the temperature controller only by authorized specialists. To do this, contact KMW customer service.

Safety instruction for the authorized specialist

Only parts that correspond to the original device data may be used for repairs.

- This refrigerated island contains electrical and mechanical parts that are essential to protect against sources of danger.
- Do not operate the refrigerated island with an external timer or a separate telecontrol system.
- Incorrect installation of the temperature controller installed in the refrigerated island can lead to an electric shock. The temperature controller is installed and adjusted at the factory.
- Do not manipulate or change the temperature controller and never open the housing.
- Make sure that the entire system is switched off when the temperature controller is mounted, wired or dismantled.
- Please note that main voltage and/or external voltage may be present when the control voltage is switched off.
- Use suitable professional tools for all work.
- Check all wiring after the temperature controller installation is complete.
- Observe the information on the maximum load for all connections (see chapter „Technical Data“ for the temperature controller).
- Keep any liquids (e.g. condensed water, cleaning agents, etc.) away from the temperature controller.

Risk of health consequences



If the refrigerated island is handled improperly or if there is a lack of control, there is a risk that the food stored in the refrigerated island will be adversely affected and possibly spoil.

If the cooling island is unexpectedly disconnected from the power supply, e.g. in the event of a power failure, the person responsible on site must ensure that the stored food is checked. Compliance with the prescribed storage temperature must be ensured.

Clean up spilled liquids in the goods area immediately.

Risk of injury



There is a risk of injury if used improperly. Check at regular intervals whether there are foreign objects in the goods space and remove them.

If defrost water leaks out of the refrigerated island, wipe it up immediately; otherwise there is a significant risk of people slipping and injuring themselves.

When cleaning the refrigerated island, always use suitable protective gloves to protect against injuries from sharp device edges.

The market operator undertakes to repair minor damage to the refrigerated island that does not impair any technical functions (e.g. dents in the housing caused by shopping trolleys).

If there is damage to the refrigeration system or the electrics, the KMW customer service must be informed immediately. Otherwise there is a considerable risk of injury.



In the event of improper handling or use, there is a risk of damaging the refrigerated island and causing property damage.

Always ensure that the refrigerated island is level on all sides and stands securely on all four feet when operating it. Observe the installation instructions in these operating instructions.

Never expose the refrigerated island to direct sunlight and keep the refrigerated island away from heat sources.

Always note that the refrigerated island must not heat up above the following temperatures: +50°C (during operation) and +70°C (during transport and storage).

Malfunctions caused by electromagnetic interference

Improper installation of the temperature controller or improper connection to the Wurm system can result in malfunctions. Only use shielded data lines for installation and connection.

When installing the data lines, keep a large distance to load lines.

Lineup

Upon delivery, unpack the refrigerated island and remove all packaging material. Check whether the delivery is complete and also pay attention to whether there are any loose parts in or on the removed packaging material.



Check whether the cooling island or individual parts show signs of damage. If this is the case, do not use the refrigerated island. Contact KMW customer service immediately.

- The installation location of the refrigerated island should correspond to the environment defined by climate class 3 (max. 25/60% RH) and be well ventilated.
 - The ventilation slots in the base must be free and must not be covered or blocked.
 - When setting up the refrigerated island, a minimum distance of 50mm to all four boundary surfaces such as walls, other devices, shelves, etc. must be maintained.
 - The installation location should not be exposed to excessive drafts or large heat sources. This can affect the performance of the refrigerated island.
 - In the case of block or row configurations, these must be ordered in advance to match.
 - Other installations and superstructures should be avoided at the installation site in order to prevent heat build-up.
 - Before using it for the first time, clean all parts of the refrigerated island as described in the „Cleaning“ and „Maintenance“ chapters.
- Do not drive the refrigerated island over steps.
 - Do not drill under any circumstances into the refrigerated island and do not modify it in any other way.
 - Place the refrigerated island at the selected location.
 - Align the refrigerated island horizontally using the four feet.
 - The refrigerated island is equipped with two sliding glass lids. Make sure that the glass lids are kept closed while the refrigerated island is in operation. Never operate the refrigerated island without a glass lid.
 - Do not subject the glass lid to any additional stress, e.g. by placing objects on it.

Installation

Electric shock warning



Faulty electrical installation or excessive mains voltage can lead to electric shock. When connecting the refrigerated island, take into account the valid regulations of the local electrical supply company for your region, as well as all generally applicable national standards and safety regulations and comply with them. Make sure that the circuit is adequately protected. Only connect the refrigerated island if the main voltage and main frequency of the socket correspond to the information on the type plate.

Only allow work at the electrical system to be carried out by KMW-authorized specialists. Also only have a damaged power cord replaced by KMW-authorized specialists.

Do not connect the refrigerated island to multiple power strips or use extension cords.

Observe the following criteria for the power supply and connection components: all supply cables must be laid by a specialist electrician in accordance with the VDE 0100-410 standard. Only connect the refrigerated island to earthed sockets with earthing contact. Never connect more than two devices to a circuit. The cable length is 300 cm. Make sure that the refrigerated island does not switch off automatically when the market light is switched off. Make sure that no other consumers are connected to the sockets for connecting the refrigerated island. KMW recommends using a cable duct on the floor with sockets built into it or mounted on it to connect the refrigerated island.

Electric circuit protection

Before you connect the refrigerated island to a circuit, you must ensure that the corresponding circuit is correctly protected. Miniature circuit breakers (LS

switches) for protection against overcurrent and residual current circuit breakers (FI switches) for protection against residual currents are required for the proper protection of the circuit.

In addition to separate solutions for LS and FI switches, it is also possible to install a combined FI/LS switch.

Slow circuit breakers

To ensure optimal operational safety, KMW recommends securing each device with its own slow-blow circuit breaker.

Slow-blow miniature circuit breakers (LS switches) represent the minimum requirement for protecting the circuit. The LS switches used for this must meet the following criteria:

- LS switch with 16A.
- KMW recommends tripping characteristic „C“; however, „B“ can also be used.

Connect and disconnect the refrigerated island from the power supply

Insert the mains plug into a properly installed safety socket to connect the cooling island to the mains. With a delay of 2 minutes the refrigerated island starts to cool automatically.



During commissioning, the controller time must be adjusted to the current time of day.

Cleaning

- Before cleaning, pull the mains plug out of the socket.
- Wipe the device surfaces with a slightly damp cloth. For heavier soiling, use neutral soap and water.
- Clean all glass panes and glass displays with a soft cotton cloth or a highly absorbent sponge cloth, a glass squeegee and a dry cotton cloth to wipe dry. Here, too, only use water and a neutral cleaning agent (pH5-7) for heavy soiling.
- In order to ensure the mobility of the sliding glass cover and to keep it running smoothly, there is a lubricant in the frame. Therefore, regularly remove dirt and dust from the top edge of the frame in order to maintain the gliding properties of the glass cover.

After cleaning with detergents, wipe all cleaned surfaces with clear water and remove all residues of the detergent from all surfaces of the refrigerated island. Remaining cleaning agent residues can damage the material over time and impair the function of the device parts. Dry all cleaned surfaces.

Never clean with:

- Rubbing, scouring or chemically aggressive cleaning agents with a strongly acidic pH value of less than 4 or a strongly alkaline pH value of more than 8
- microfiber cloths
- Hard or sharp metal objects (e.g. glass plane, glass blade, steel wool)
- Steam or high-pressure cleaner.

Defrost

The refrigerated island is equipped with an automatic defrosting system that works on the principle of so-called „hot gas defrosting“. It is therefore usually not necessary to defrost the refrigerated island manually. The start time of the automatic defrosting process is preset at the factory. In exceptional cases it may be necessary to defrost the refrigerated island manually, e.g. due to a fault, improper installation, overloading, after cleaning or due to other sources of interference. The way you do this depends on whether your cooling island is connected to a worm system or not.

Defrosting devices without a bus connection

Disconnect the cooling island from the power supply by pulling the power plug out of the socket.

- Wait about a minute.
- Reconnect power to the refrigerated island by plugging the power cord into a properly installed grounded electrical outlet.
- After reconnection, the refrigerated island automatically starts the defrosting process. After the defrosting process is complete, the refrigerated island automatically switches back to cooling mode.
- After the defrosting process is complete, check the temperature in the refrigerator compartment of the refrigerated island.
- In the case of very heavy icing, it may be necessary to repeat this process up to three times.

Defrosting devices with bus connection

In the case of refrigerated islands that are connected to a Wurm system via a bus connection, the manual defrosting process is also initiated via the store software or according to separate instructions directly on the thermostat controller. Please note the information and operating instructions for the Wurm system used.

Maintenance

The refrigerated island is maintenance-free. For reasons of hygiene, the manufacturer recommends completely defrosting and cleaning the refrigerated island once or twice a year.

The condenser and the condensate drain should also be cleaned once or twice a year by suitable, expert personnel or a specialist refrigeration company.



Attention!
The surface of the condenser could be hot.

Risk of ignition and explosion



A flammable gas-air mixture can form due to any existing leaks in a refrigeration system operated with the refrigerant R290. Sparks emitted by an electrical device (e.g. a vacuum cleaner) can ignite the gas-air mixture that may be present. For devices that are operated with the refrigerant R290, remove condensation water only with a dry cloth or sponge. Do not use electric wet vacuum cleaners or similar.

Never hit or scrape off any existing layer of ice or frost with pointed objects or tools. This could damage the evaporator.

Risk of injury



Danger!

In the event of improper handling or use, there is a risk of injury from rotating fans and sharp edges.

When cleaning below the floor display, the mains plug must be pulled out before cleaning.

Always use suitable protective gloves when cleaning the cooling island to avoid injury.

Danger of short circuit



Water or other liquids that have entered the housing can cause a short circuit. Be careful not to let water or other liquids get into the cooling island housing.



Risk of damage!

Improper cleaning and maintenance can damage the refrigerated island or parts of it. Do not use any abrasive, aggressive or easily flammable cleaning agents, brushes with metal or nylon bristles or sharp and metal cleaning objects for cleaning. These can damage the surfaces. Never use glass cleaners or other cleaning agents to clean the coated glass surfaces. These destroy the sensitive coating.

Do not use heaters to manually defrost the refrigerated island.

Decommissioning, transport and storage

If you plan to take the refrigerated island out of service for an extended period of time, follow these steps:

- Remove all goods from the refrigerated island.
- Turn off the refrigerated island.
- Wait until the temperature of the refrigerated island has equalized to the room temperature.
- Clean all parts of the refrigerated island as described in the chapters „Cleaning“ and „Maintenance“. The air circulation prevents unpleasant odors and mold spores from forming in the refrigerator compartment.
- Make sure that the refrigerated island is level during transport and that it stands on all four feet securely.
- Fasten the refrigerated island against slipping when transporting it in a vehicle.

Improper storage can damage the refrigerated island. Never leave the refrigerated island in a place where it is exposed to direct sunlight. The refrigerated island can be damaged by the high temperatures.

Please note that disruptions to the Wurm system will occur if you disconnect a cooling island connected via a bus connection from the mains by pulling the mains plug out of the socket.

Product details and functionality

This chapter provides information on the product details and functionality of the refrigerated island and the individual components that are important for the proper handling of the refrigeration island.

Climate class

Cooling devices must always correspond to one of the climate classes 0 to 8 according to the ISO 23953-2 standard. The climate class specifies specifications for the environment in which the device is operated. The cooling island is designed as a device of climate class 3, for which a maximum ambient temperature of 25°C and a maximum relative humidity of 60% are specified. If the actual temperature and humidity values are above the specified values, the energy efficiency of the cooling island may decrease. If the actual values significantly exceed the specifications, functional restrictions of the refrigerated island are to be expected.

Only operate the refrigerated island in an environment that meets the requirements of climate class 3.

Cooling unit

The refrigeration unit integrated in the refrigerated island begins to work with a delay of around 2 minutes after the refrigeration island is switched on. The refrigerated island does not have a separate on/off switch for the refrigeration unit, i.e. by connecting the refrigerated island to the mains you put it into operation at the same time. Take all necessary preparatory measures before you connect the cooling island to the mains (see chapter Commissioning).

Housing and cooling storage

The refrigerated island is structured as followed:

- In the lower part „machine compartment“ is the cooling system and the electrics.
- The four outer panes of glass form the perimeter of the cold room. Inside the cold room is the goods space for the display of the food to be cooled. This is limited on both sides by the glass

panes and the inner baffle pane.

- A defrosting channel is located below the floor display in the cold room. The defrost channel is used to drain condensed water.

Condensation occurs during proper operation of the refrigerated island; the moisture contained in the air freezes on the cooling surfaces. For the correspondingly necessary defrosting process, the cooling island has an automatic defrosting system, with the help of which the refrigerated island defrosts at regular intervals automatically. It is not necessary to defrost the refrigerated island manually usually.

To do this, observe the procedure in the "Cleaning and maintenance" chapter.

Temperature controller / Refrigeration controller

With the help of the temperature controller, the temperature in the goods area is regulated to an adjustable setpoint.



Risk of damage!

The temperature controller is set electronically. All necessary settings for temperature control and automatic defrosting are preset at the factory. Changes to the setting may only be made by authorized specialist personnel. Failure to do so may result in damage to the goods.

The refrigeration controller installed in the refrigeration island is the Modell CRDP-XP



or alternative model



CRA from Wurm GmbH & Co. KG Elektronische Systeme, Morsbachtalstraße 30, D-42857 Remscheid, www.wurm.de.

Troubleshooting and Service



Electric shock and risk of ignition!
If work is carried out improperly on the electrical system or on the refrigeration system improperly: there is considerable potential for danger.

- Only have work on the electrical system and the refrigeration system carried out by authorized KMW customer service.
- Never allow untrained or unauthorized persons to work on the electrical system or the refrigeration system.

In the case of a fault, check the following points:

- Is the power cord plugged in properly?
- Is there voltage at the socket?
- Is the display active on devices with an electronic temperature controller?

If the temperature in the refrigerator compartment is too high, check the following points:

- are the goods stored were too warm stored in accidentally?
- Did you have a longer power outage previously?

Contact KMW customer service if the fault is not due to any of the causes listed here. When contacting KMW Customer Service, always give the serial number of the refrigerated island and the type of fault or a description of the malfunction. Contact KMW customer service if loud noises and/or strong vibrations occur on the device in any case.

Contact for service queries (e.g. with regard to maintenance and service, repairs, etc.) in principle to your regionally responsible KMW customer service.

If you do not know the customer service responsible for your region, you can contact the central KMW customer service

alternatively at the following address:

Contact address:

KMW Kühlmöbelwerk Limburg GmbH
Limburger Strasse 80
D- 65555 Limburg
Telefon 06431 599 0
Service 0800 59 95 95 9

E-Mail: kmw@kmw-limburg.com
Service: service@kmw-limburg.com
Internet: www.kmw-limburg.com

Technical data

Year of Manufacturing	since 2022
-----------------------	------------

Temperature class	M1 (-1°C bis +5°C) M2 (-1°C bis +7°C)
Climate class	III (25°C; 60% rF)
Supply voltage	230V; 50Hz
Power consumption	246W
Power consumption at temperature class M1/24h	KIM1GXT100H100AL108 1,92 kWh KIM2GXT100H100AL108 1,81 kWh KIM1GXT00H100AL140 2,1kWh KIM1GXT117H100AL140 2,1 kWh KIM2GXT100H100AL140 1,6 kWh KIM1GXT100H100AL200 2,55 kWh
Protection art	IP44
Protection class	1
Refrigerant	R290
Capacity	0,15kg

Dimensions KIM..108	L/W/H
External dimensions	1080x980x1005mm
Internal dimensions	950x700x412mm
Display area	0,67 m ²
Weight	140 kg

Dimensions KIM..100/140 KIM..117/140	L/W/H
External dimensions	1395x980x1005mm
Internal dimensions	1265x700x412mm
Display area	0,89 m ²
Weight	188 kg

Dimensions KIM..200	L/W/H
External dimensions	1980x980x1005mm
Internal dimensions	1875x700x412mm
Display area	1,31 m ²

Weight	260 kg
--------	--------

Energy label climate class III (25°C;60%r.F.)

KIM1GXT100H100AL108

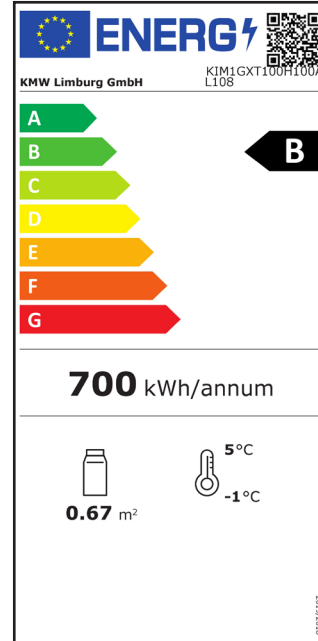

KIM2GXT100H100AL108

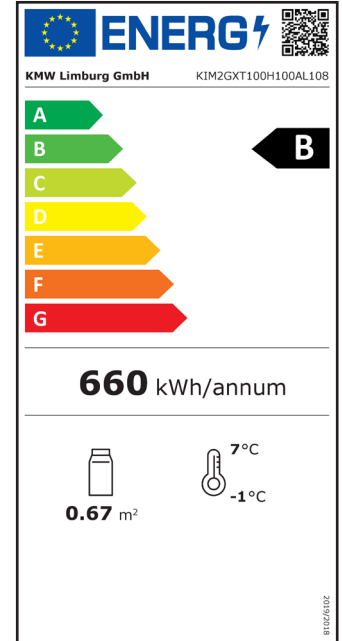

KIM1GXT100H100AL140

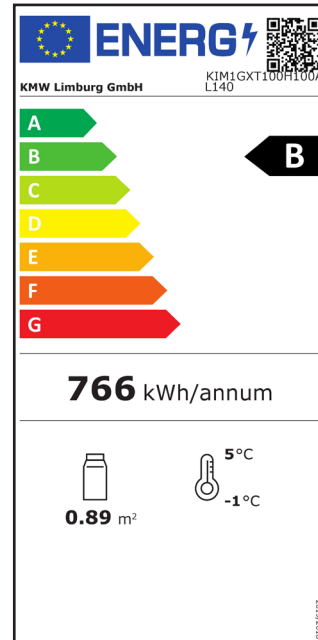

KIM2GXT100H100AL140

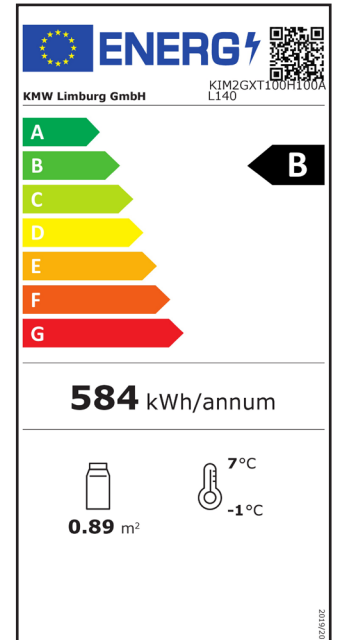

KIM1GXT100H100AL200

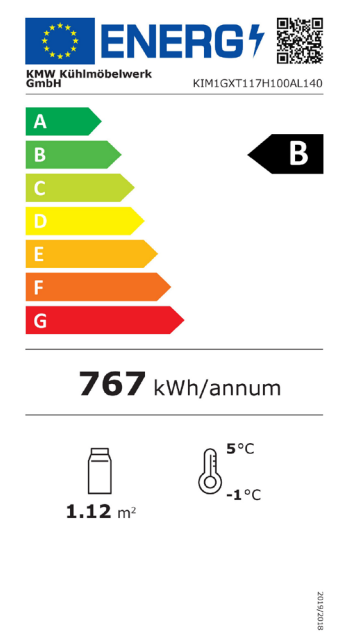
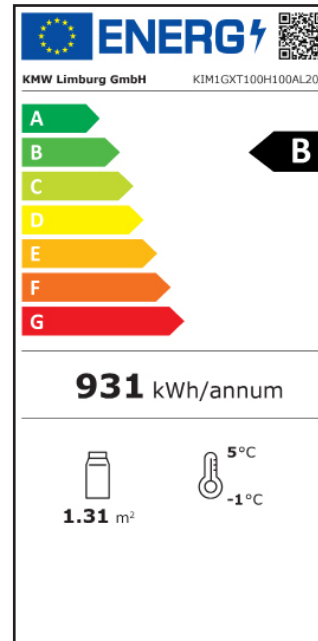

Disposal

Dispose of packaging



Discard the packaging unmixed. Give cardboard to the waste paper, foils to the recyclables collection.

Dispose the cooling island

(Applicable in the European Union and other European countries with systems for separate collection of recyclables)

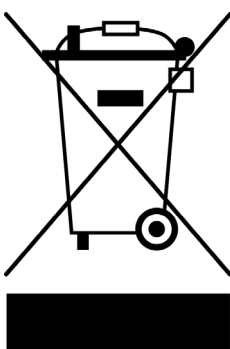

Old devices must not be disposed of in the household waste! Dispose of the refrigerated cooler according to the disposal laws and regulations applicable in your country (e.g. WEEE) and in accordance with the regulations of the local disposal partner.

Declaration of Conformity

KMW[®]

KÜHLMÖBELWERK

Qualität aus Deutschland

EU Declaration of Conformity

Manufacturer: KMW Kühlmöbelwerk Limburg GmbH
Limburger Strasse 80
65555 Limburg

Product name: Commercial refrigerated cabinets

Type designation: According to device model designation

The serial number, important technical data and test marks are given on the rating plate of each individual refrigeration appliance.

The manufacturer is solely responsible for issuing this declaration of conformity.

The product described above complies with the provisions of the directives:

- Machinery Directive 2006/42/EC of May 17, 2006
- EMC Directive 2014/30/EC of February 26, 2014

The compliance of the product described above with the essential requirements of the directive is demonstrated by the technical documentation and full compliance with the following standards:

Applied harmonized standards for Machinery Directive 2006/42/EG

DIN EN 60335-1:2020-08; VDE 0700-1:2020-08

DIN EN 60335-289:2018-10; VDE 0700-89:2018-10

DIN EN 62233:2008-11; VDE 0700-366:2008-11

DIN EN 62233 Correction 1:2009-04; VDE 0700-366 correction 1:2009-04

DIN EN ISO 12100:2011-03

Applied harmonized standards for EMC directive 2014/30/EU:

DIN EN IEC 61000-3-2:2019-12; VDE 0838-2:2019-12

DIN EN 61000-3-3:2020-07; VDE 0838-3:2020-07

DIN EN 55014-1:2018-08; VDE 0875-14-1

DIN EN 55014-2:2016-01; VDE 0875-13:2016-01

Other standards applied in the design and construction of the products:

DIN EN 378-1:2021-06

DIN EN 378-2:2018-04

DIN EN ISO 23953-1:2016-03

DIN EN ISO 23953-2:2016-03

DIN EN IEC 60079-0:2019-09 for R-290 devices, R-600a devices

In case of a technical change to the product described above that has not been agreed with us, this declaration loses its validity.

KMW Kühlmöbelwerk Limburg GmbH



Technical Director



Managing Director

Imprint

KMW Kühlmöbelwerk Limburg GmbH

Gewerbegebiet Offheim
Limburger Straße 80
D-65555 Limburg

Tel.: +49 (0) 64 31 / 5 99 - 0
Fax: +49 (0) 64 31 / 5 39 67
Service: +49 (0)800 / 599 59 59
(kostenfrei aus dem dt. Festnetz)

kmw@kmw-limburg.com
www.kmw-limburg.com

© Copyright

Reprint or duplication (also in extracts) only with the permission of:
KMW Kühlmöbelwerk Limburg GmbH Limburger Straße 80
D-65555 Limburg

This publication, including all of its parts, is protected by copyright.

Any use outside the narrow limits of copyright without the consent of KMW Kühlmöbelwerk Limburg GmbH is inadmissible and punishable.

This applies in particular to reproductions, translations, microfilms and the feeding and processing in electronic systems.

Manufactured in 2022 by:

KMW Kühlmöbelwerk Limburg GmbH Limburger Straße 80
D-65555 Limburg

Article Number: 3042584